



BALKAN JUDO ASSOCIATION

BALKAN JUDO CHAMPIONSHIP BOYS AND GIRLS U14

June 06 - 07, 2026 - BITOLA, NORTH MACEDONIA

42 KG
24 Judoka

POOL A

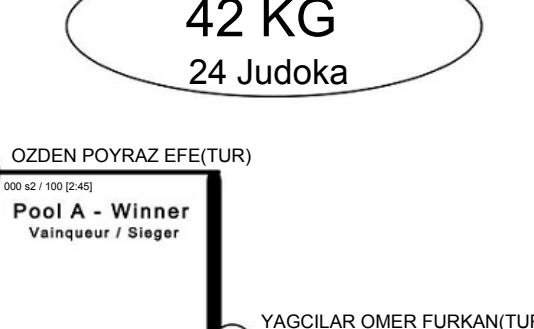
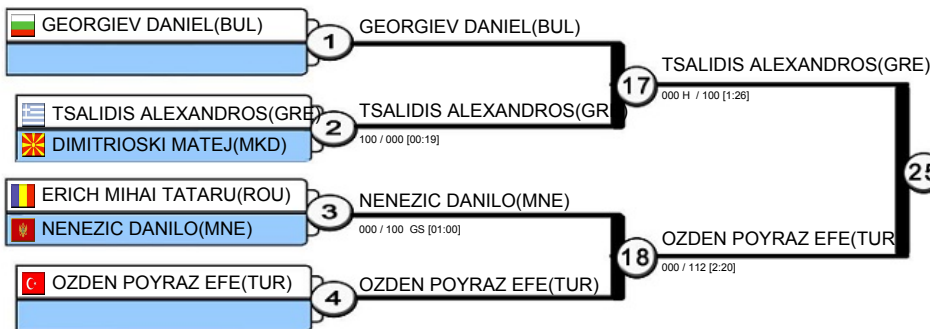

POOL B

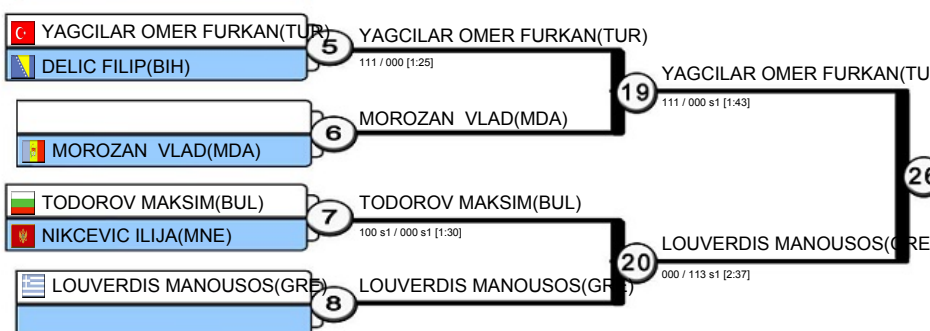

POOL C

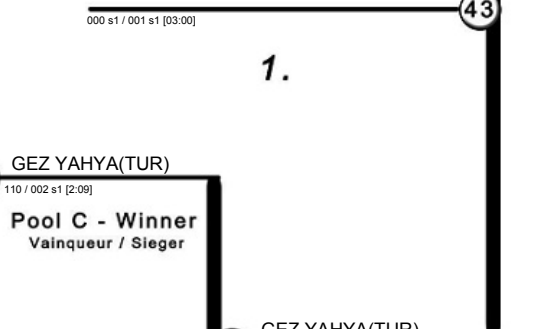

POOL D

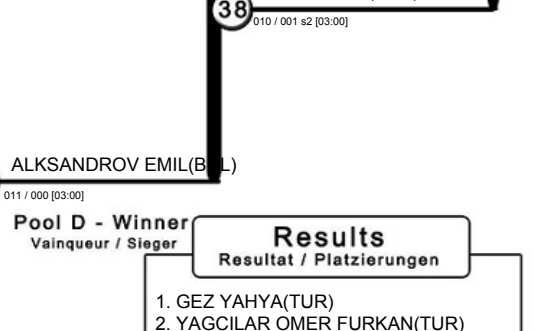
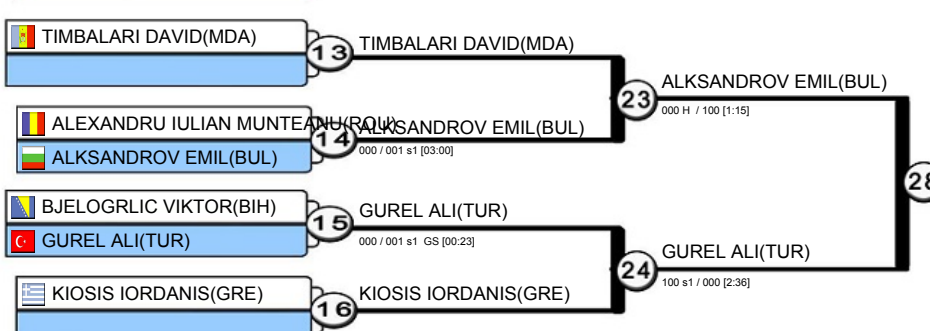

Results
Resultat / Platzierungen

1. GEZ YAHYA (TUR)
2. YAGCILAR OMER FURKAN (TUR)
3. NENEZIC DANILO (MNE)
3. STOYANOV MARTIN (BUL)
5. ALKSANDROV EMIL (BUL)
5. OZDEN POYRAZ EFE (TUR)
7. MOROZAN VLAD (MDA)
7. GUREL ALI (TUR)

Repechage / Trostrunde

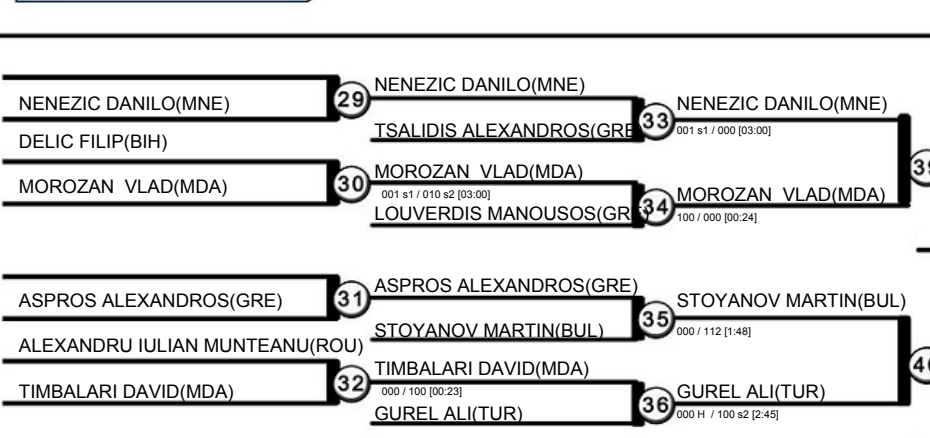



BALKAN JUDO ASSOCIATION

BALKAN JUDO CHAMPIONSHIP BOYS AND GIRLS U14

June 06 - 07, 2026 - BITOLA, NORTH MACEDONIA

50 KG
28 Judoka

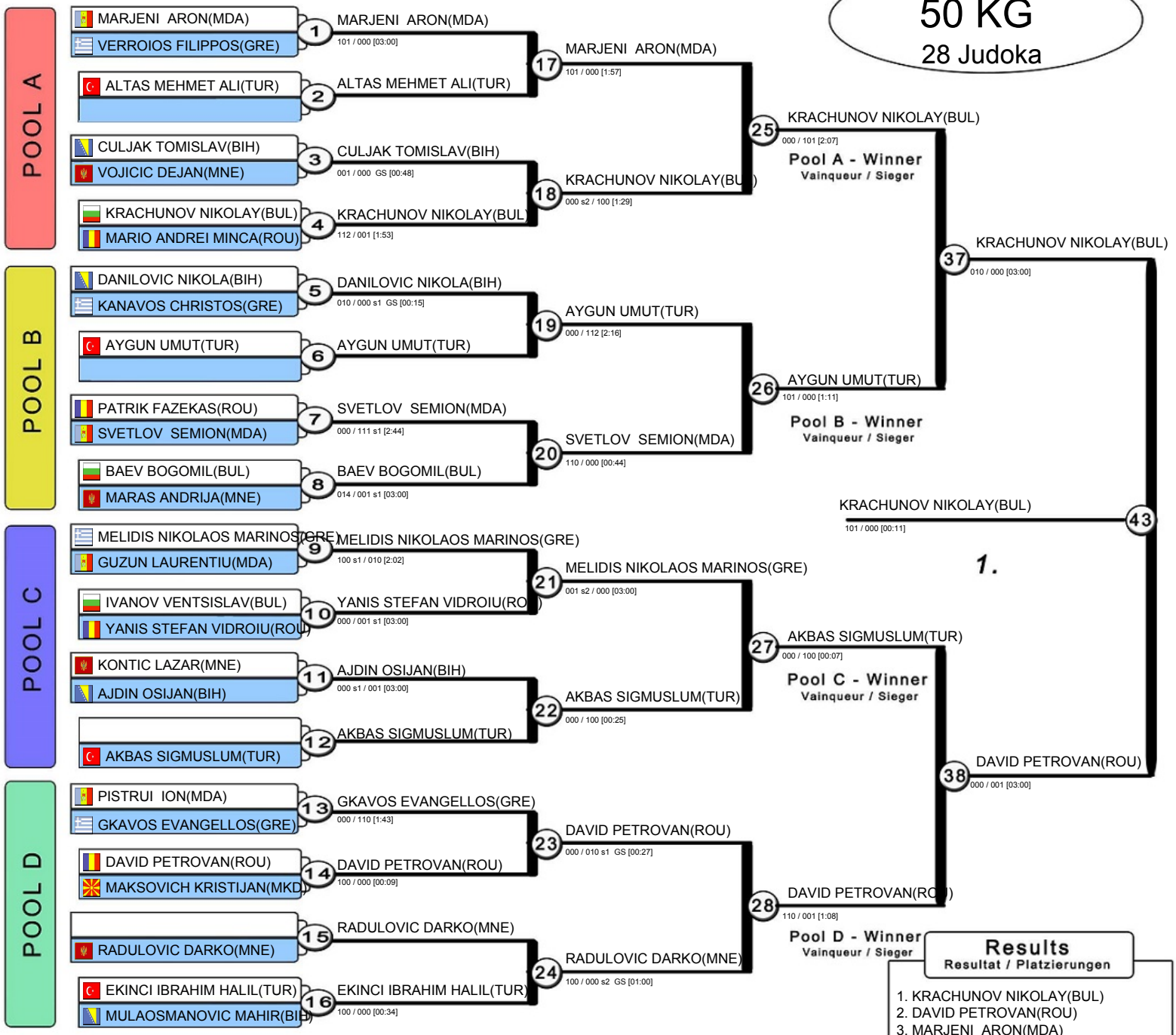

Results
Resultat / Platzierungen

1. KRACHUNOV NIKOLAY(BUL)
2. DAVID PETROVAN(ROU)
3. MARJENI ARON(MDA)
3. AYGUN UMUT(TUR)
5. AKBAS SIGMUSLUM(TUR)
5. RADULOVIC DARKO(MNE)
7. MELIDIS NIKOLAOS MARINOS(GRE)



BALKAN JUDO ASSOCIATION

BALKAN JUDO CHAMPIONSHIP BOYS AND GIRLS U14

June 06 - 07, 2026 - BITOLA, NORTH MACEDONIA

55 KG
29 Judoka

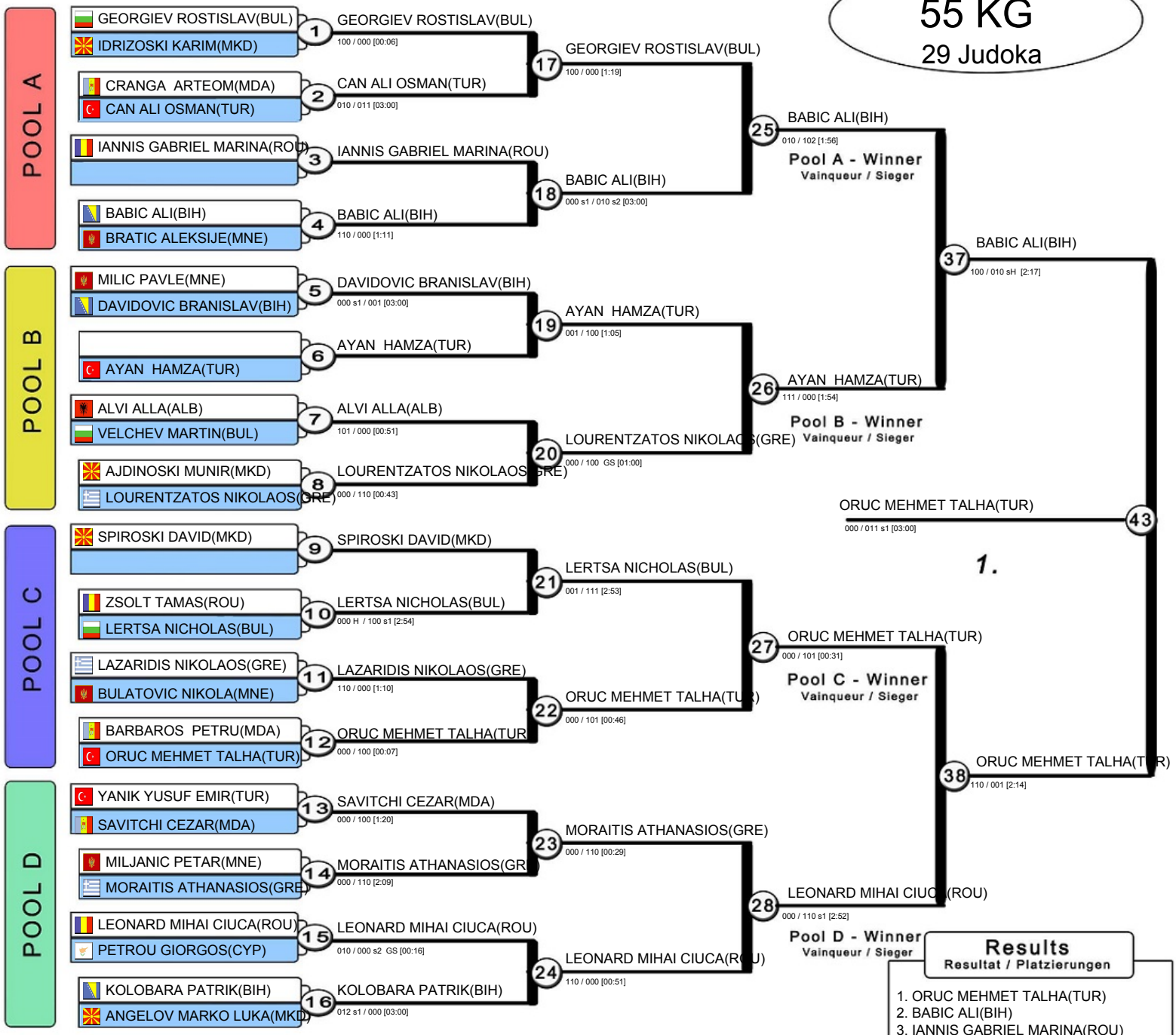

1.

Pool C - Winner
Vainqueur / Sieger

Pool D - Winner
Vainqueur / Sieger

- Results**
Resultat / Platzierungen
1. ORUC MEHMET TALHA (TUR)
 2. BABIC ALI (BIH)
 3. IANNIS GABRIEL MARINA (ROU)
 4. AYAN HAMZA (TUR)
 5. LEONARD MIHAI CIUCA (ROU)
 6. BARBAROS PETRU (MDA)
 7. LOURENTZATOS NIKOLAOS (GRE)
 8. MORAITIS ATHANASIOS (GRE)

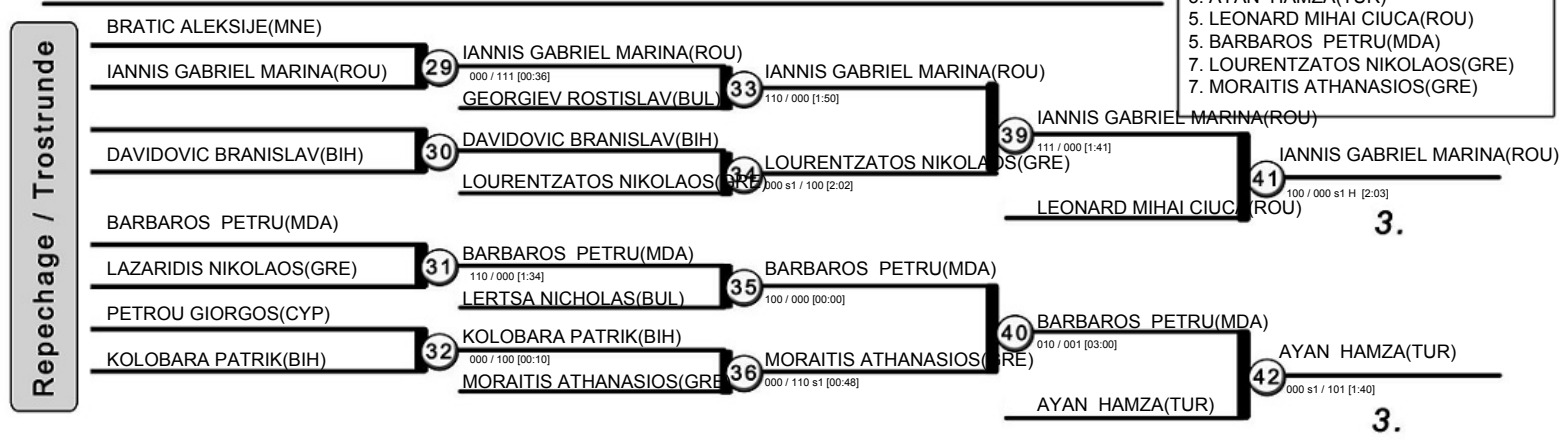



BALKAN JUDO ASSOCIATION

BALKAN JUDO CHAMPIONSHIP BOYS AND GIRLS U14

June 06 - 07, 2026 - BITOLA, NORTH MACEDONIA

60 KG
26 Judoka

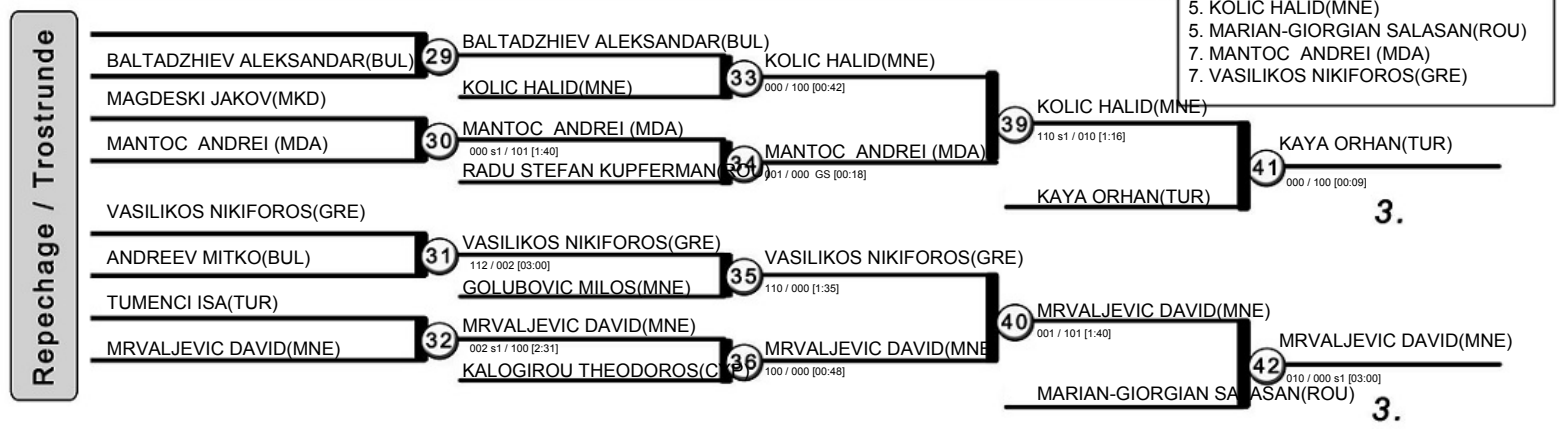
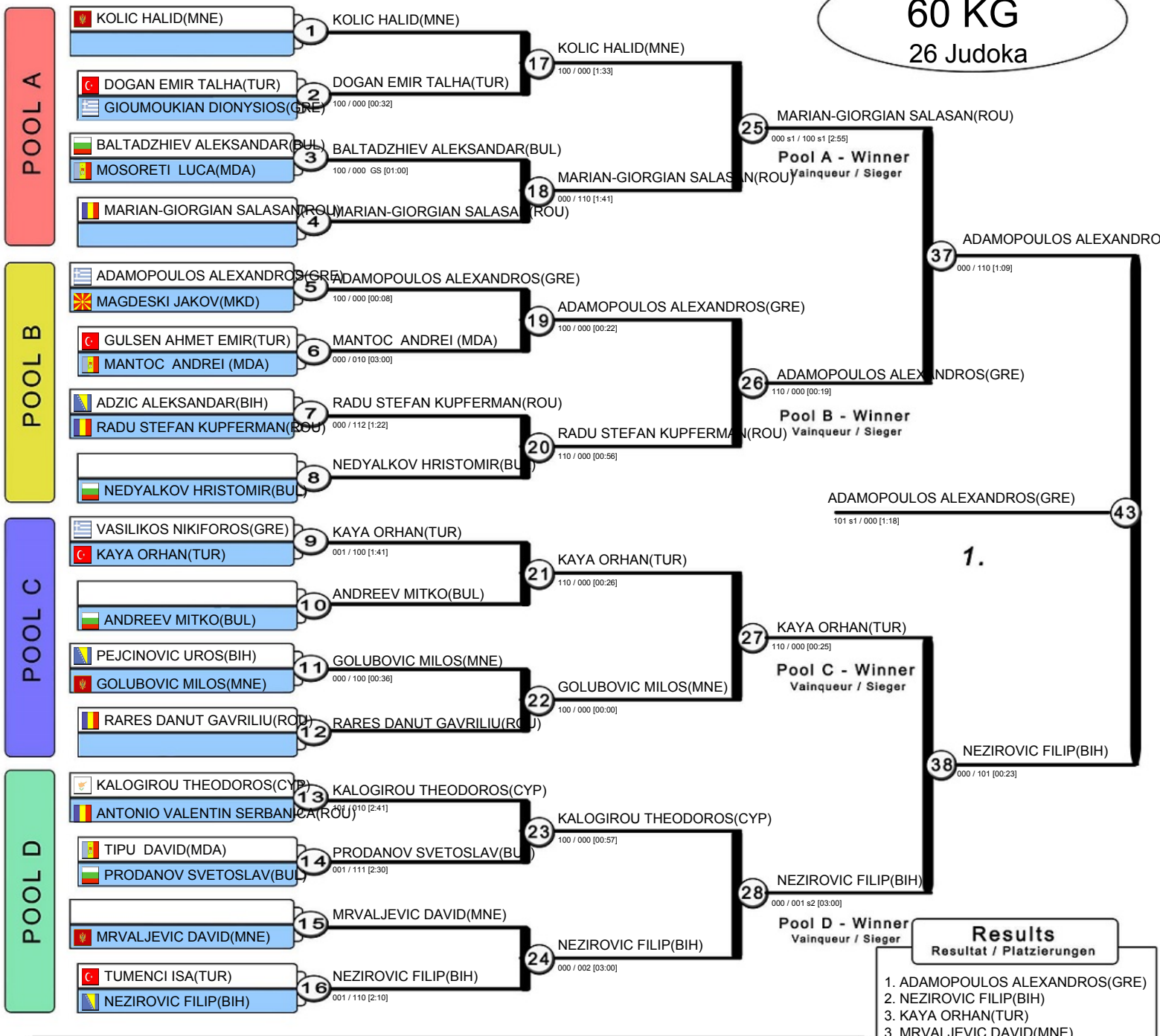



BALKAN JUDO ASSOCIATION

BALKAN JUDO CHAMPIONSHIP BOYS AND GIRLS U14

June 06 - 07, 2026 - BITOLA, NORTH MACEDONIA

66 KG
23 Judoka

POOL A

1 SAGLAM MELIH EMRE(TUR) vs 17 SAGLAM MELIH EMRE(TUR) [111 / 000 [00:47]]

2 MYLONAS EVANGELOS(GRE) vs 18 TRCKOV VIKTOR(MKD) [000 / 100 [00:30]]

3 TRCKOV VIKTOR(MKD) vs 19 LATINOVIC LAZAR(BIH) [100 / 000 [00:24]]

4 MILOSEVIC DEJAN(BIH) vs 20 ALEXANDRU MOROSAN(ROU) [000 / 100 [00:08]]

25 SAGLAM MELIH EMRE(TUR)
Pool A - Winner
Vainqueur / Sieger

POOL B

5 LATINOVIC LAZAR(BIH) vs 21 DANIEL EROSS(ROU) [000 / 100 [1:18]]

6 PANTAZELOS GEORGIOS(GRE) vs 22 UNAL MUSTAFA OKMEN(TUR) [000 / 110 [1:03]]

7 ILIEV IVAYLO(BUL) vs 23 AJDINOSKI ENIL(MKD) [111 / 000 [1:07]]

8 USTA OMER ASAF(TUR) vs 24 SPASOV VASIL(BUL) [000 / 100 [00:14]]

9 ALEXANDRU MOROSAN(ROU) vs 25 SAGLAM MELIH EMRE(TUR) [010 s2 / 000 s1 [03:00]]

26 ALEXANDRU MOROSAN(ROU)
Pool B - Winner
Vainqueur / Sieger

POOL C

9 SONJA ERNAD(BIH) vs 27 DANIEL EROSS(ROU) [003 / 000 [03:00]]

10 DANIEL EROSS(ROU) vs 28 SPASOV VASIL(BUL) [000 / 111 [1:46]]

11 RISTOV KRISTIJAN(MKD) vs 29 KENC ENOH(MDA) [000 / 110 s1 [00:58]]

12 UNAL MUSTAFA OKMEN(TUR) vs 30 USTA OMER ASAF(TUR) [001 s1 / 000 s2 GS [00:09]]

27 DANIEL EROSS(ROU)
Pool C - Winner
Vainqueur / Sieger

POOL D

13 AJDINOSKI ENIL(MKD) vs 31 SONJA ERNAD(BIH) [000 sH / 100 s1 GS [00:01]]

14 KAGKALOS NIKOLAOS(GRE) vs 32 KUTEMUR RAMAZAN(TUR) [100 / 000 [00:19]]

15 SPASOV VASIL(BUL) vs 33 TRCKOV VIKTOR(MKD) [000 / 110 s1 [00:58]]

16 KUTEMUR RAMAZAN(TUR) vs 34 LATINOVIC LAZAR(BIH) [000 s1 / 112 [2:13]]

28 SPASOV VASIL(BUL)
Pool D - Winner
Vainqueur / Sieger

Repechage / Trostrunde

29 KENC ENOH(MDA) vs 35 UNAL MUSTAFA OKMEN(TUR) [000 / 112 [1:45]]

30 USTA OMER ASAF(TUR) vs 36 AJDINOSKI ENIL(MKD) [000 s1 / 102 [1:30]]

31 SONJA ERNAD(BIH) vs 37 SAGLAM MELIH EMRE(TUR) [112 / 002 [2:53]]

32 KUTEMUR RAMAZAN(TUR) vs 38 DANIEL EROSS(ROU) [001 / 000 s2 [03:00]]

39 TRCKOV VIKTOR(MKD)
Pool A - Winner
Vainqueur / Sieger

40 AJDINOSKI ENIL(MKD)
Pool B - Winner
Vainqueur / Sieger

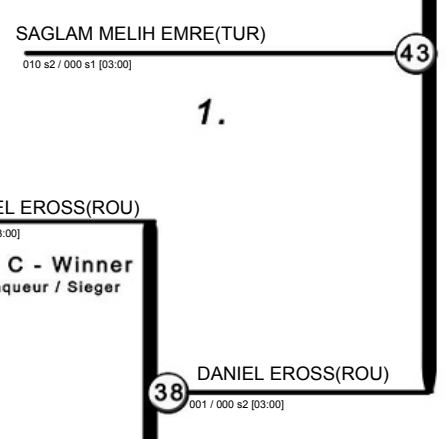

- Results**
Resultat / Platzierungen
1. SAGLAM MELIH EMRE(TUR)
 2. DANIEL EROSS(ROU)
 3. TRCKOV VIKTOR(MKD)
 3. ALEXANDRU MOROSAN(ROU)
 5. SPASOV VASIL(BUL)
 5. AJDINOSKI ENIL(MKD)
 7. LATINOVIC LAZAR(BIH)
 7. UNAL MUSTAFA OKMEN(TUR)



BALKAN JUDO ASSOCIATION
BALKAN JUDO CHAMPIONSHIP BOYS AND GIRLS U14
 June 06 - 07, 2026 - BITOLA, NORTH MACEDONIA

73 KG
 15 Judoka

POOL A

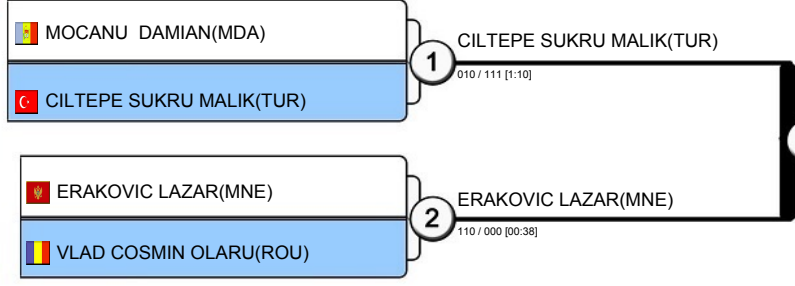

Pool A - Winner
 Vainqueur / Sieger

POOL B

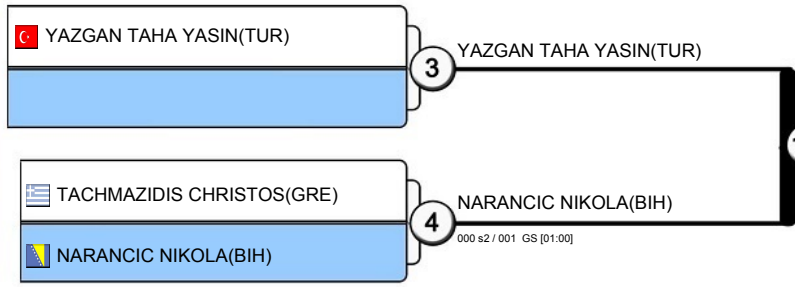

Pool B - Winner
 Vainqueur / Sieger

POOL C

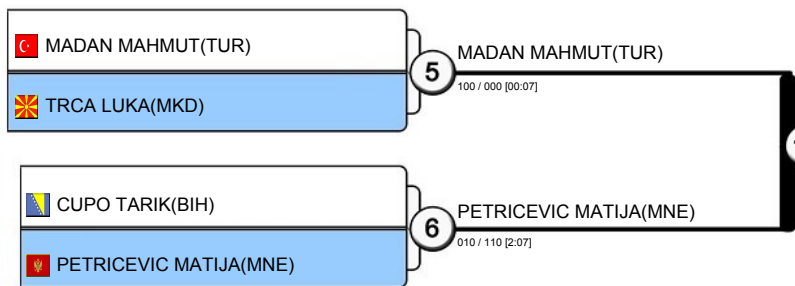

Pool C - Winner
 Vainqueur / Sieger

POOL D

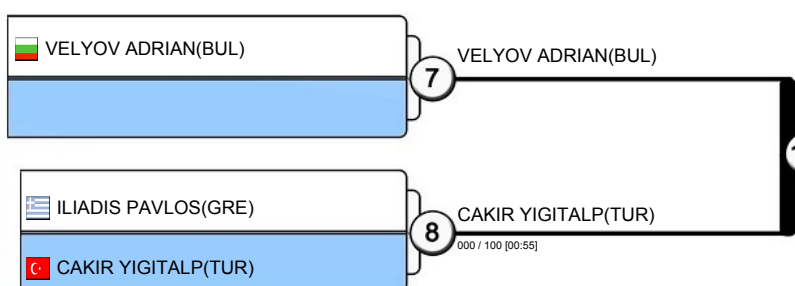

Pool D - Winner
 Vainqueur / Sieger

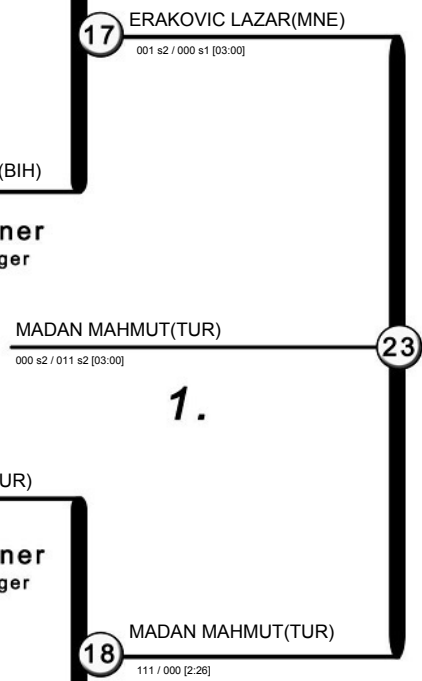

1.

- Results**
 Resultat / Platzierungen
1. MADAN MAHMUT(TUR)
 2. ERAKOVIC LAZAR(MNE)
 3. CILTEPE SUKRU MALIK(TUR)
 3. NARANCIC NIKOLA(BIH)
 5. CAKIR YIGITALP(TUR)
 5. PETRICEVIC MATIJA(MNE)
 7. TACHMAZIDIS CHRISTOS(GRE)
 7. ILIADIS PAVLOS(GRE)

Repechage / Trostrunde

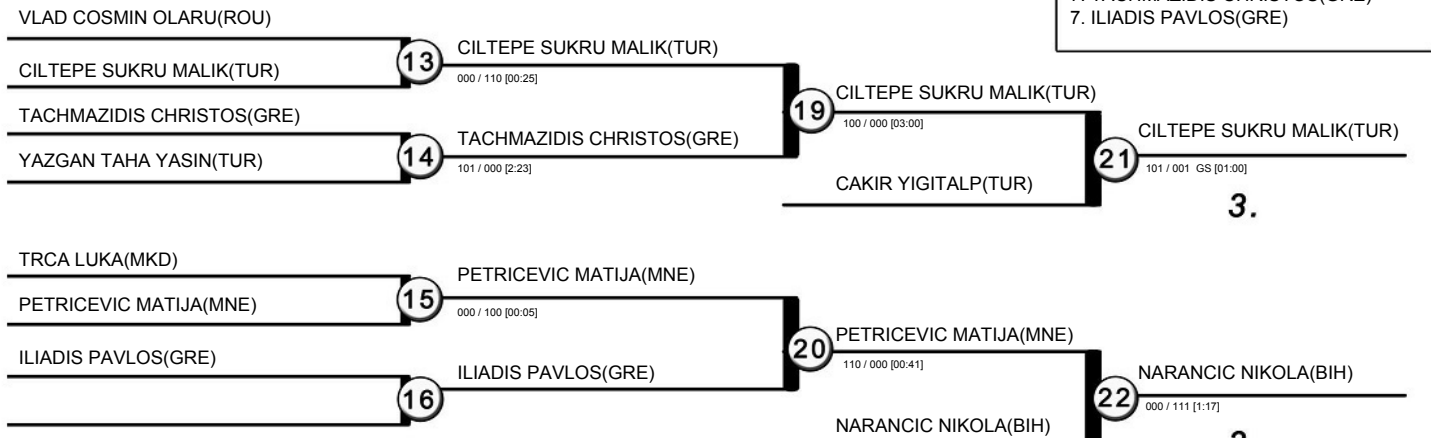

3.

3.



BALKAN JUDO ASSOCIATION

BALKAN JUDO CHAMPIONSHIP BOYS AND GIRLS U14

June 06 07, 2026 - BITOLA, NORTH MACEDONIA

+73 KG
23 Judoka

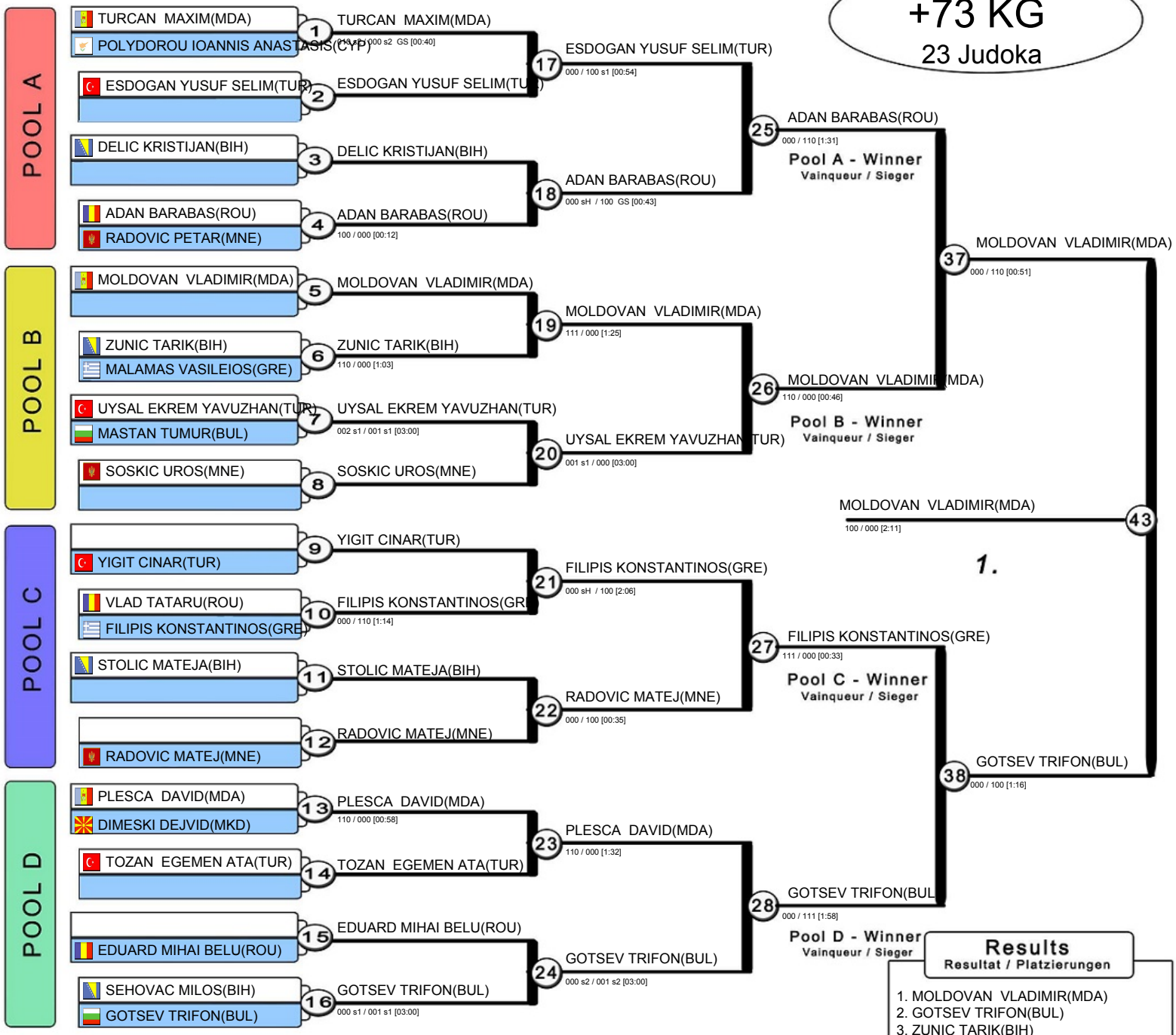

Results
Resultat / Platzierungen

1. MOLDOVAN VLADIMIR(MDA)
2. GOTSEV TRIFON(BUL)
3. ZUNIC TARIK(BIH)
3. ADAN BARABAS(ROU)
5. FILIPIS KONSTANTINOS(GRE)
5. PLESCA DAVID(MDA)
7. DELIC KRISTIЈAN(BIH)
7. YIGIT CINAR(TUR)

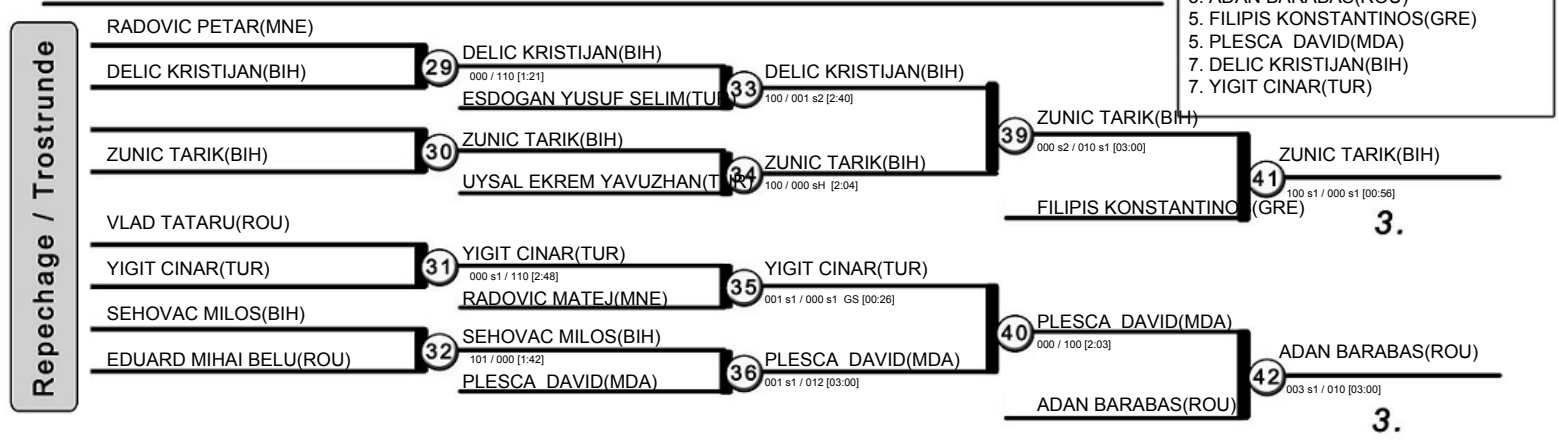



BALKAN JUDO ASSOCIATION
BALKAN JUDO CHAMPIONSHIP BOYS AND GIRLS U14
 June 06 - 07 , 2026 - BITOLA, NORTH MACEDONIA

32 KG
 15 Judoka

POOL A

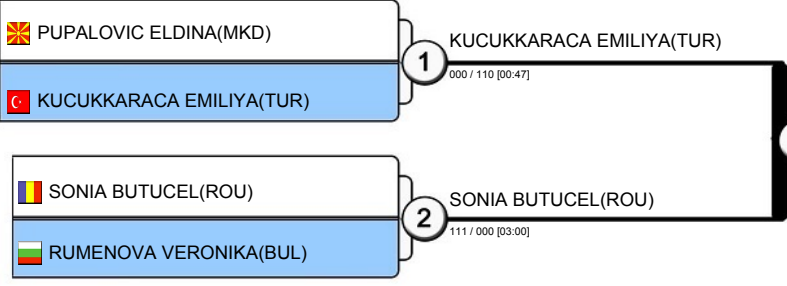

POOL B

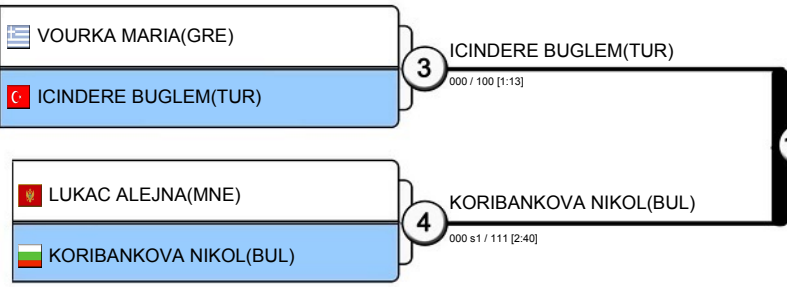

POOL C

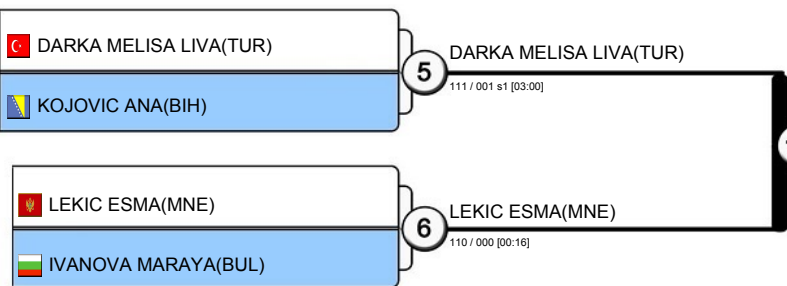

POOL D

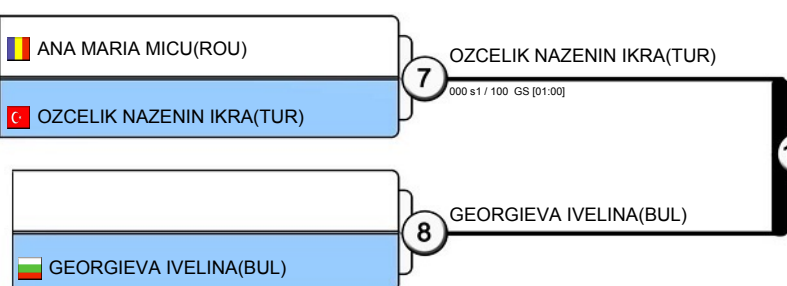

Pool A - Winner
 Vainqueur / Sieger

Pool B - Winner
 Vainqueur / Sieger

Pool C - Winner
 Vainqueur / Sieger

Pool D - Winner
 Vainqueur / Sieger

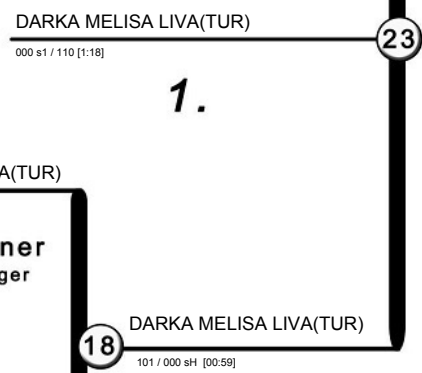

- Results**
 Resultat / Platzierungen
1. DANKA MELISA LIVA(TUR)
 2. KUCUKKARACA EMILIYA(TUR)
 3. SONIA BUTUCEL(ROU)
 3. ICINDERE BUGLEM(TUR)
 5. OZCELIK NAZENIN IKRA(TUR)
 5. KOJOVIC ANA(BIH)
 7. KORIBANKOVA NIKOL(BUL)
 7. GEORGIEVA IVELINA(BUL)

Repechage / Trostrunde

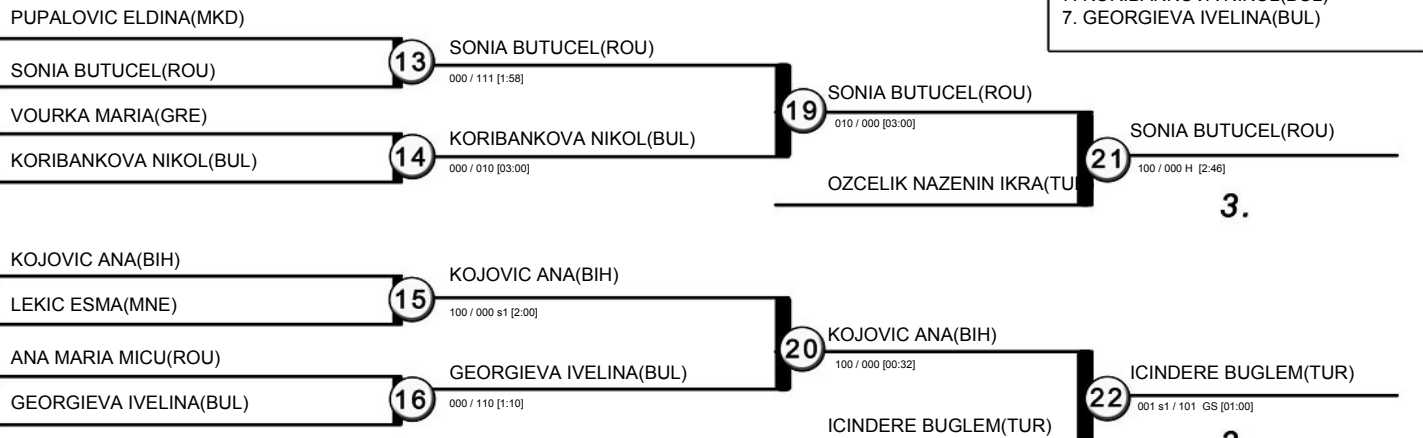



BALKAN JUDO ASSOCIATION

BALKAN JUDO CHAMPIONSHIP BOYS AND GIRLS U14

June 06 - 07, 2026 - BITOLA, NORTH MACEDONIA

36 KG
21 Judoka

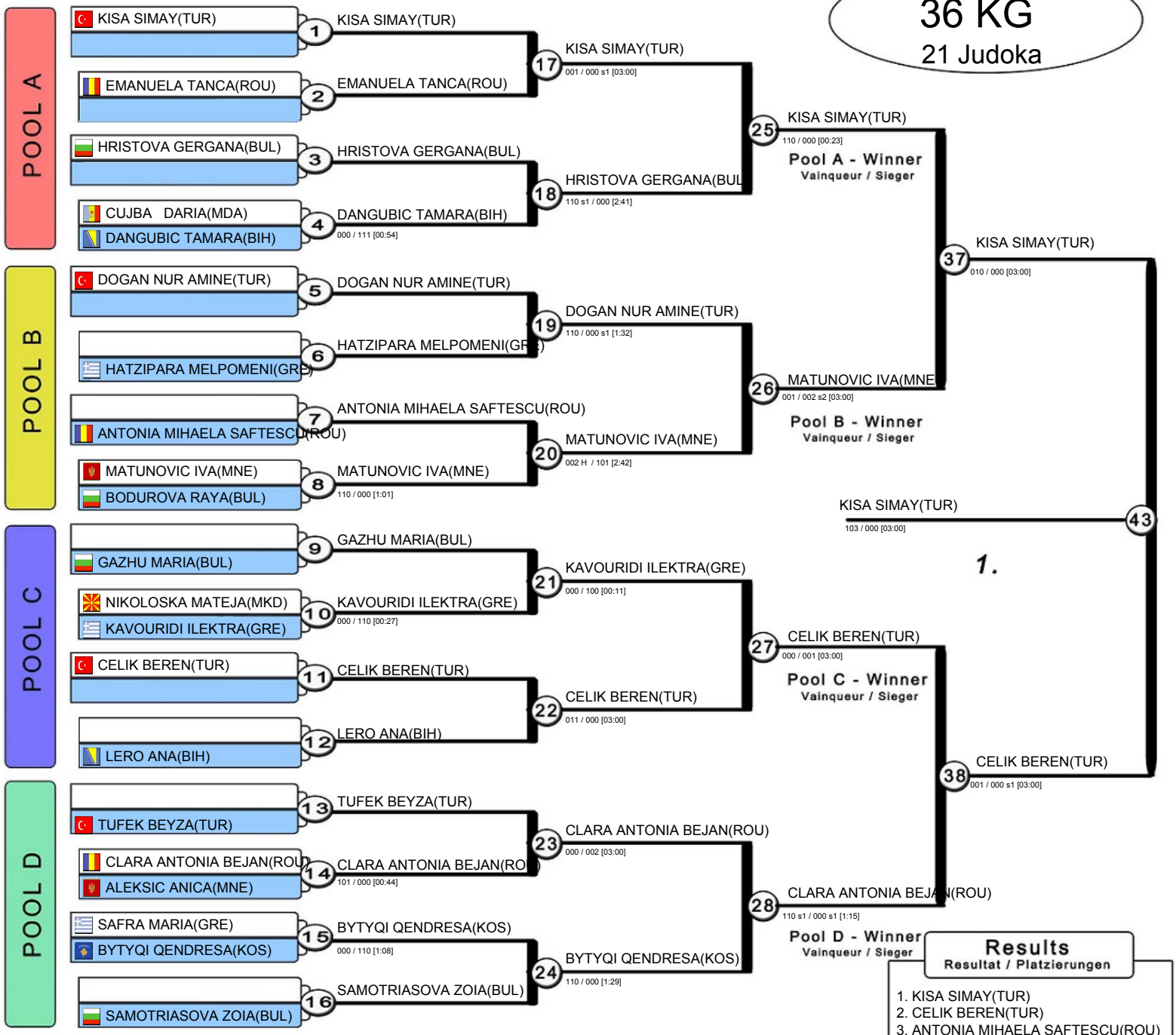

1.

Pool C - Winner
Vainqueur / Sieger

Pool D - Winner
Vainqueur / Sieger

Results
Resultat / Platzierungen

1. KISA SIMAY (TUR)
2. CELIK BEREN (TUR)
3. ANTONIA MIHAELA SAFTESCU (ROU)
3. BYTYQI QENDRESA (KOS)
5. CLARA ANTONIA BEJAN (ROU)
5. EMANUELA TANCA (ROU)
7. LERO ANA (BIH)

3.

3.

Repechage / Trostrunde



BALKAN JUDO ASSOCIATION

BALKAN JUDO CHAMPIONSHIP BOYS AND GIRLS U14

June 06 07, 2026 - BITOLA, NORTH MACEDONIA

40 KG
22 Judoka

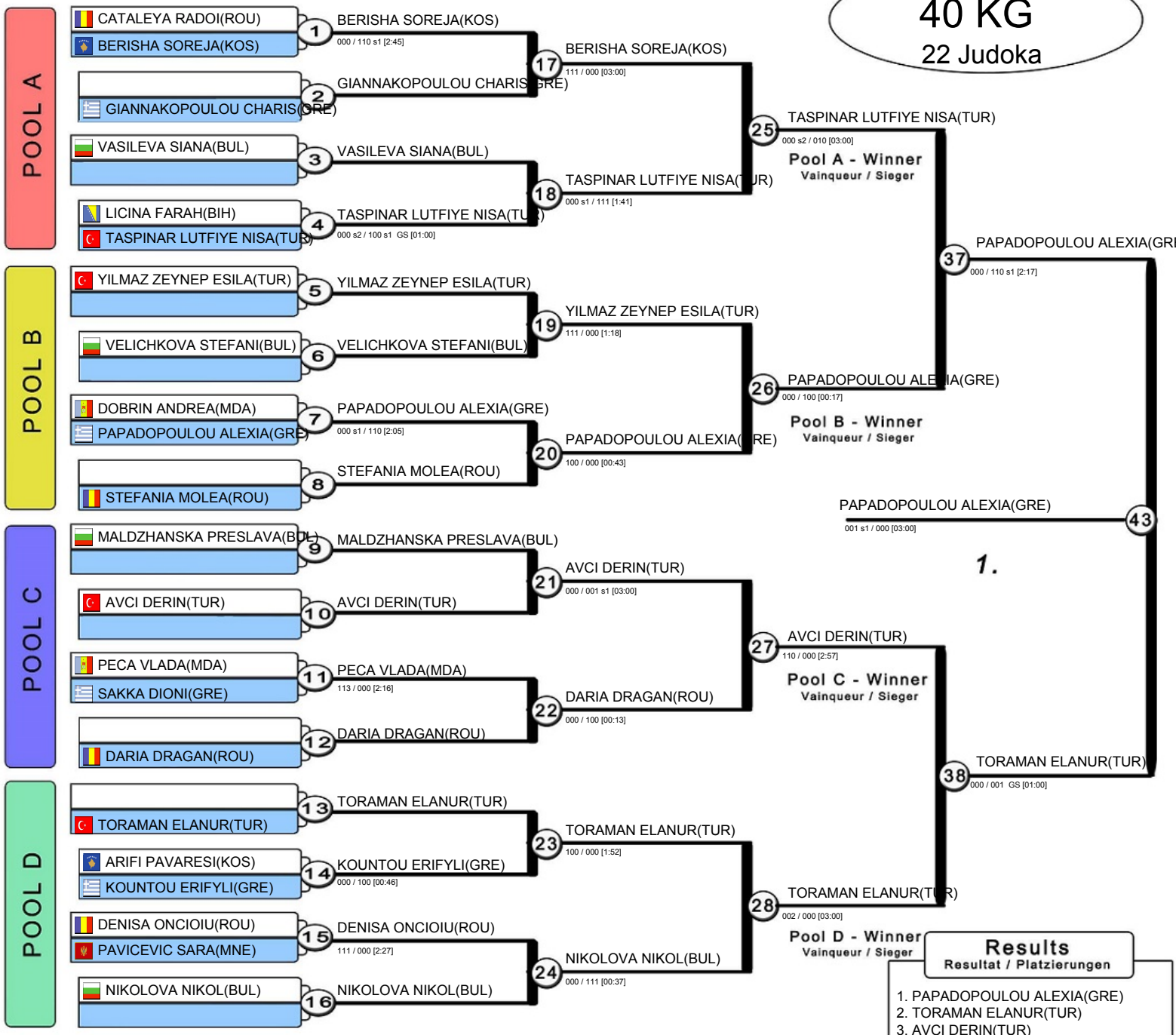

Results
Resultat / Platzierungen

1. PAPADOPOULOU ALEXIA(GRE)
2. TORAMAN ELANUR(TUR)
3. AVCI DERIN(TUR)
4. TASPINAR LUTFIYE NISA(TUR)
5. YILMAZ ZEYNEP ESILA(TUR)
6. NIKOLOVA NIKOL(BUL)
7. BERISHA SOREJA(KOS)
8. MALDZHANSKA PRESLAVA(BUL)

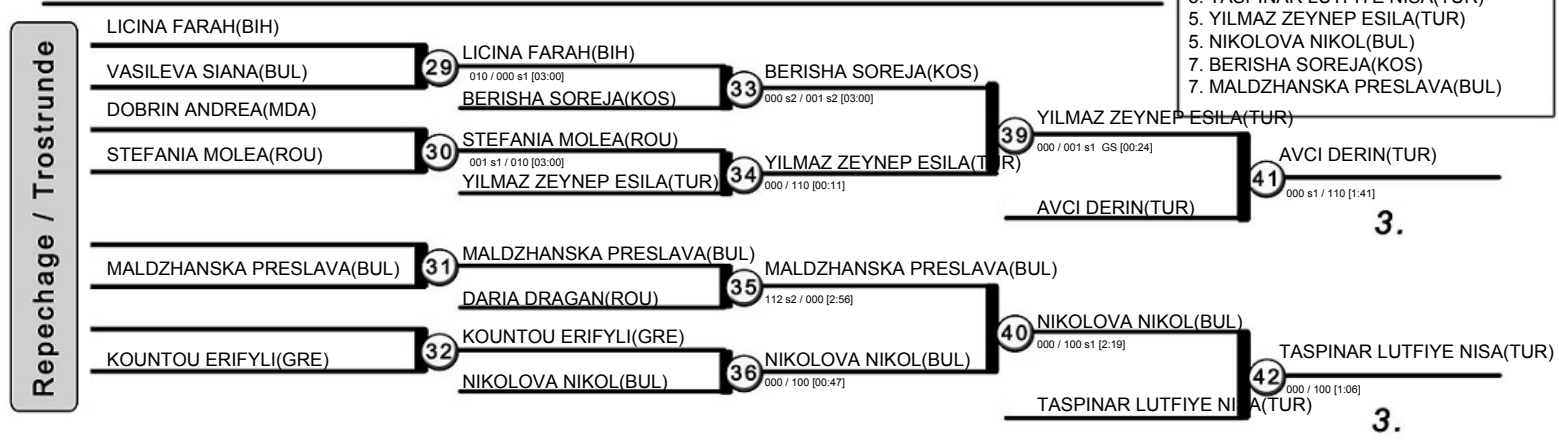



BALKAN JUDO ASSOCIATION

BALKAN JUDO CHAMPIONSHIP BOYS AND GIRLS U14

June 06 07, 2026 - BITOLA, NORTH MACEDONIA

44 KG
24 Judoka

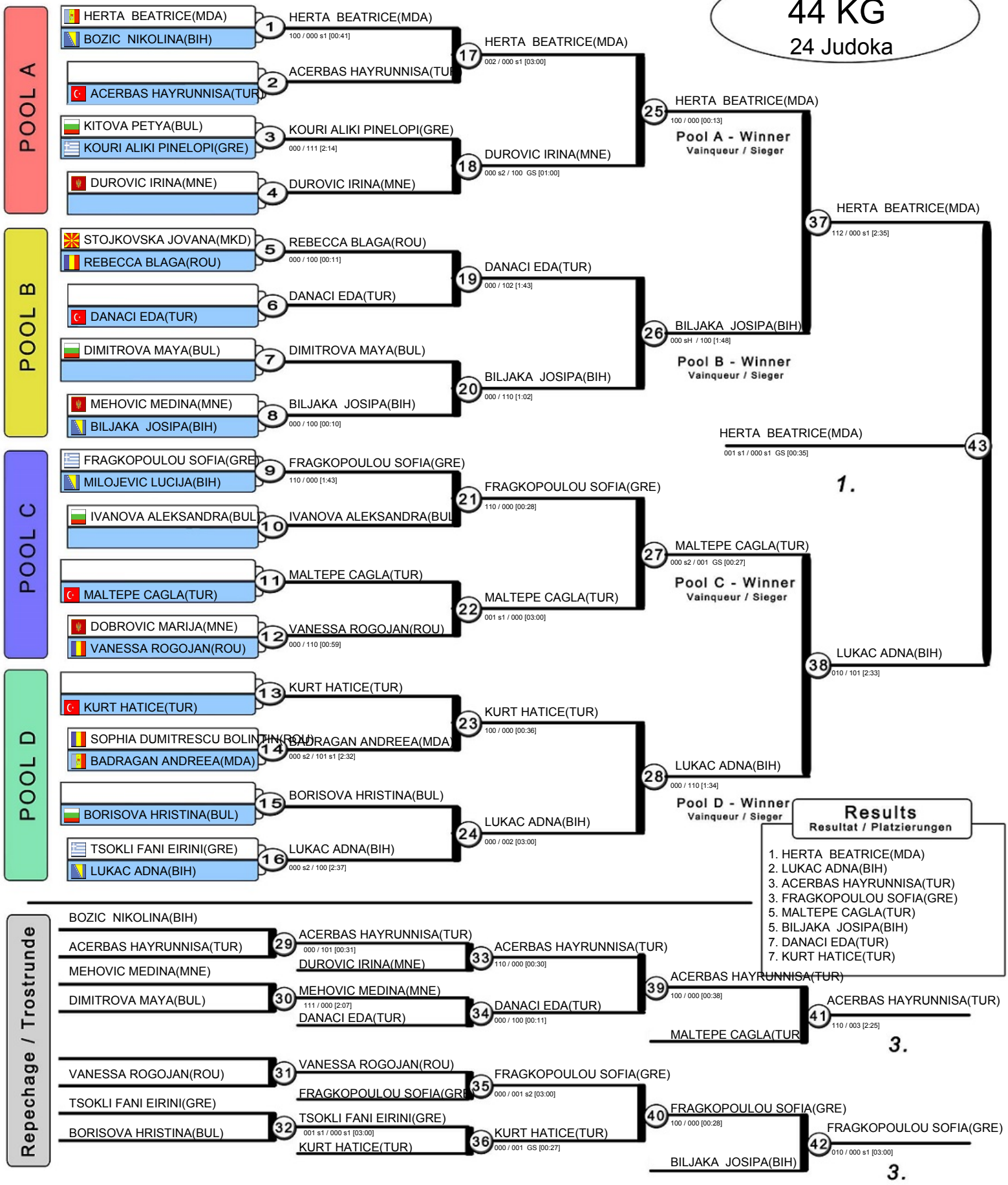

Results
Resultat / Platzierungen

1. HERTA BEATRICE(MDA)
2. LUKAC ADNA(BIH)
3. ACERBAS HAYRUNNISA(TUR)
3. FRAGKOPOULOU SOFIA(GRE)
5. MALTEPE CAGLA(TUR)
7. DANACI EDA(TUR)
7. KURT HATICE(TUR)



BALKAN JUDO ASSOCIATION

BALKAN JUDO CHAMPIONSHIP BOYS AND GIRLS U14

June 06 - 07, 2026 - BITOLA, NORTH MACEDONIA

48 KG
22 Judoka

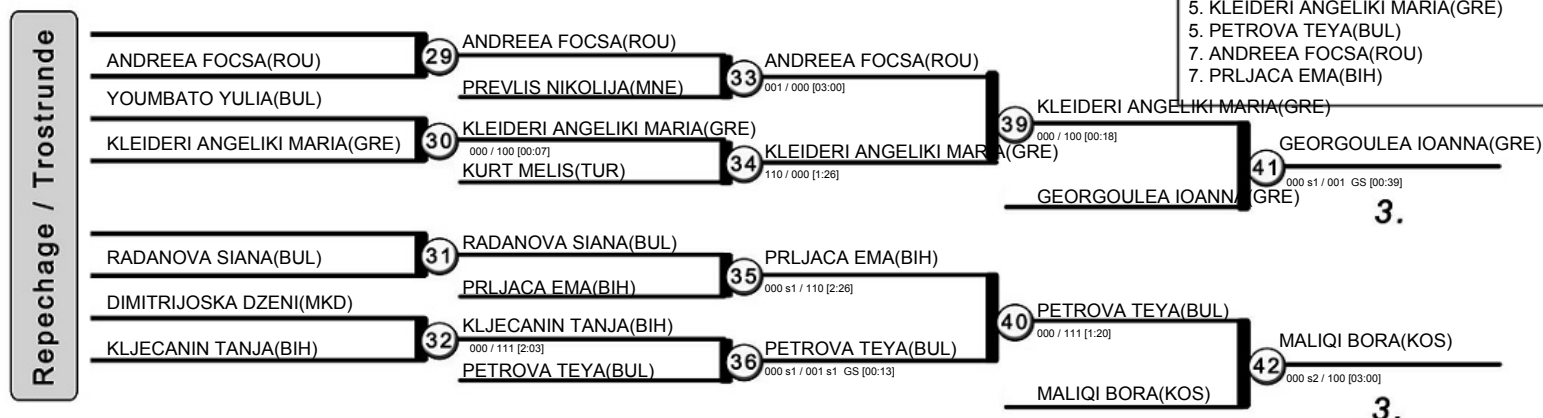
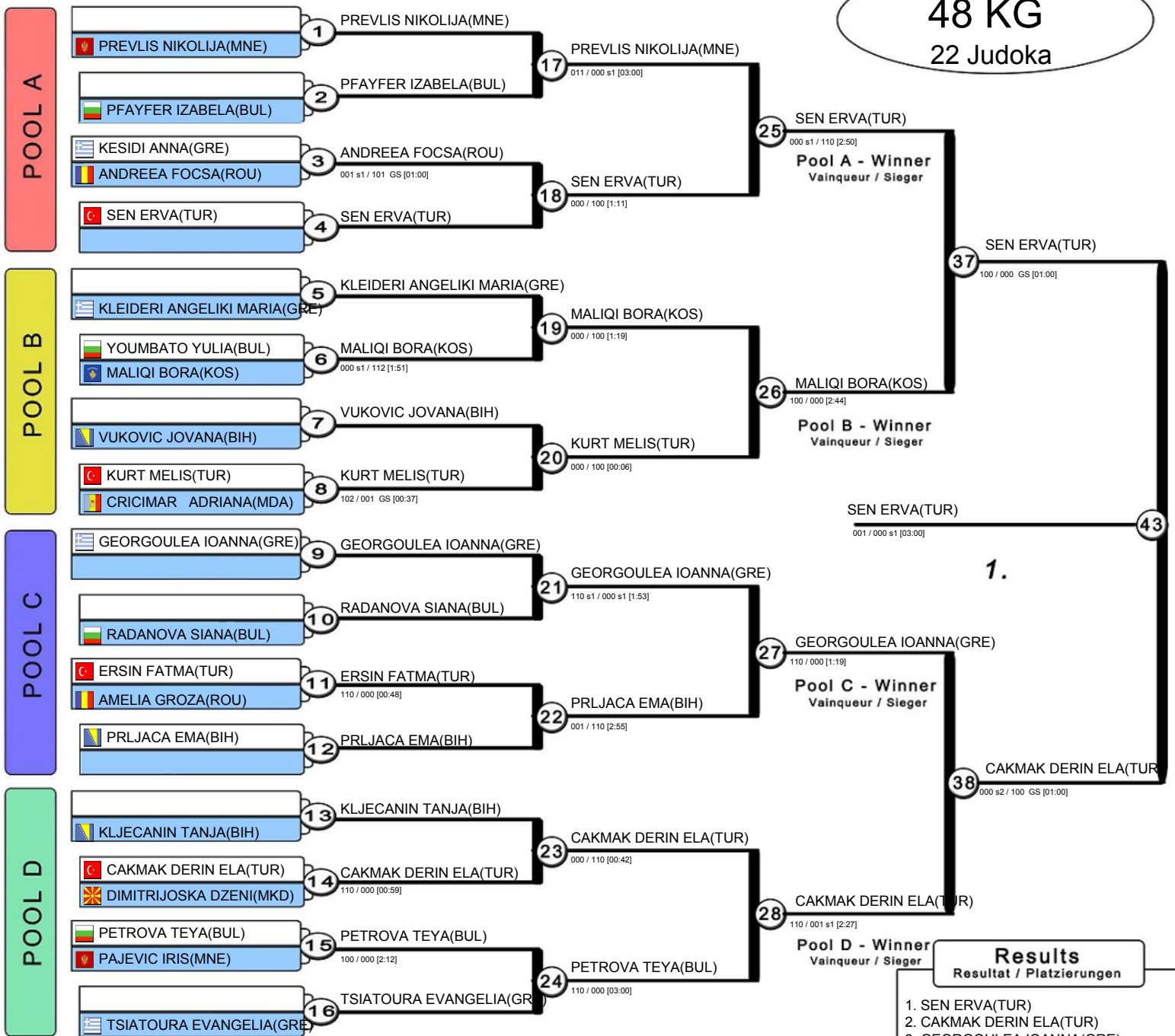



BALKAN JUDO ASSOCIATION

BALKAN JUDO CHAMPIONSHIP BOYS AND GIRLS U14

June 06 - 07, 2026 - BITOLA, NORTH MACEDONIA

52 KG
18 Judoka

POOL A

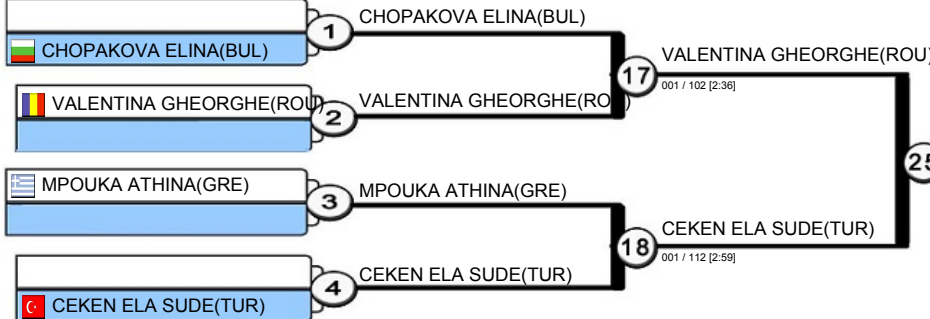

Pool A - Winner
Vainqueur / Sieger

POOL B

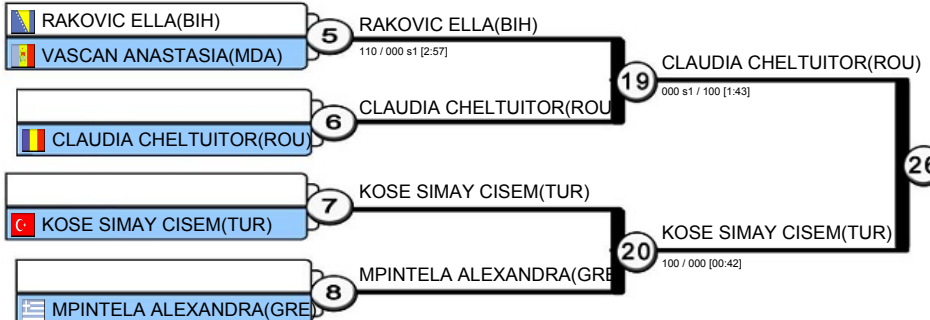

Pool B - Winner
Vainqueur / Sieger

POOL C

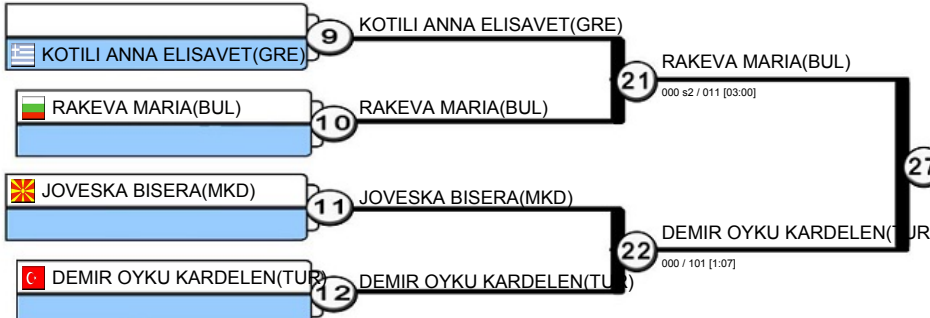

Pool C - Winner
Vainqueur / Sieger

POOL D

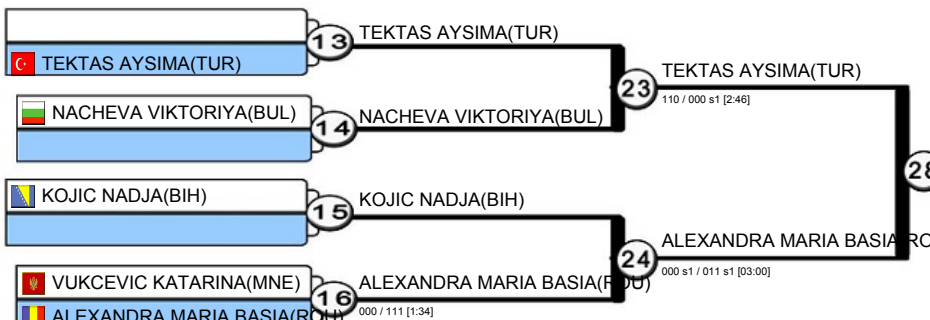

Pool D - Winner
Vainqueur / Sieger

Results
Resultat / Platzierungen

1. DEMIR OYKU KARDELEN(TUR)
2. KOSE SIMAY CISEM(TUR)
3. CEKEN ELA SUDE(TUR)
3. RAKEVA MARIA(BUL)
5. TEKTAS AYSIMA(TUR)
7. MPINTELA ALEXANDRA(GRE)
7. ALEXANDRA MARIA BASIA(ROU)

Repechage / Trostrunde

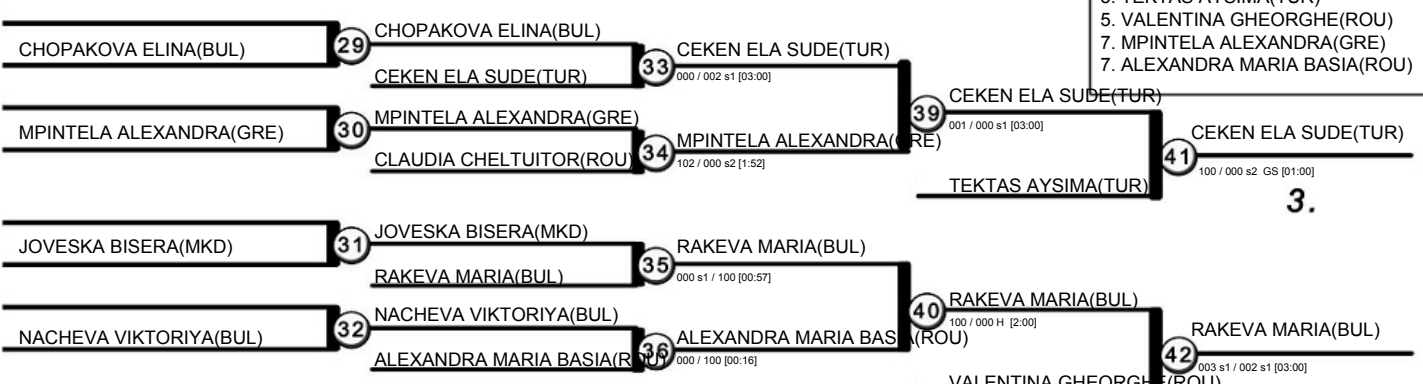

3.

3.



BALKAN JUDO ASSOCIATION

BALKAN JUDO CHAMPIONSHIP BOYS AND GIRLS U14

June 06 - 07, 2026 - BITOLA, NORTH MACEDONIA

57 KG
19 Judoka

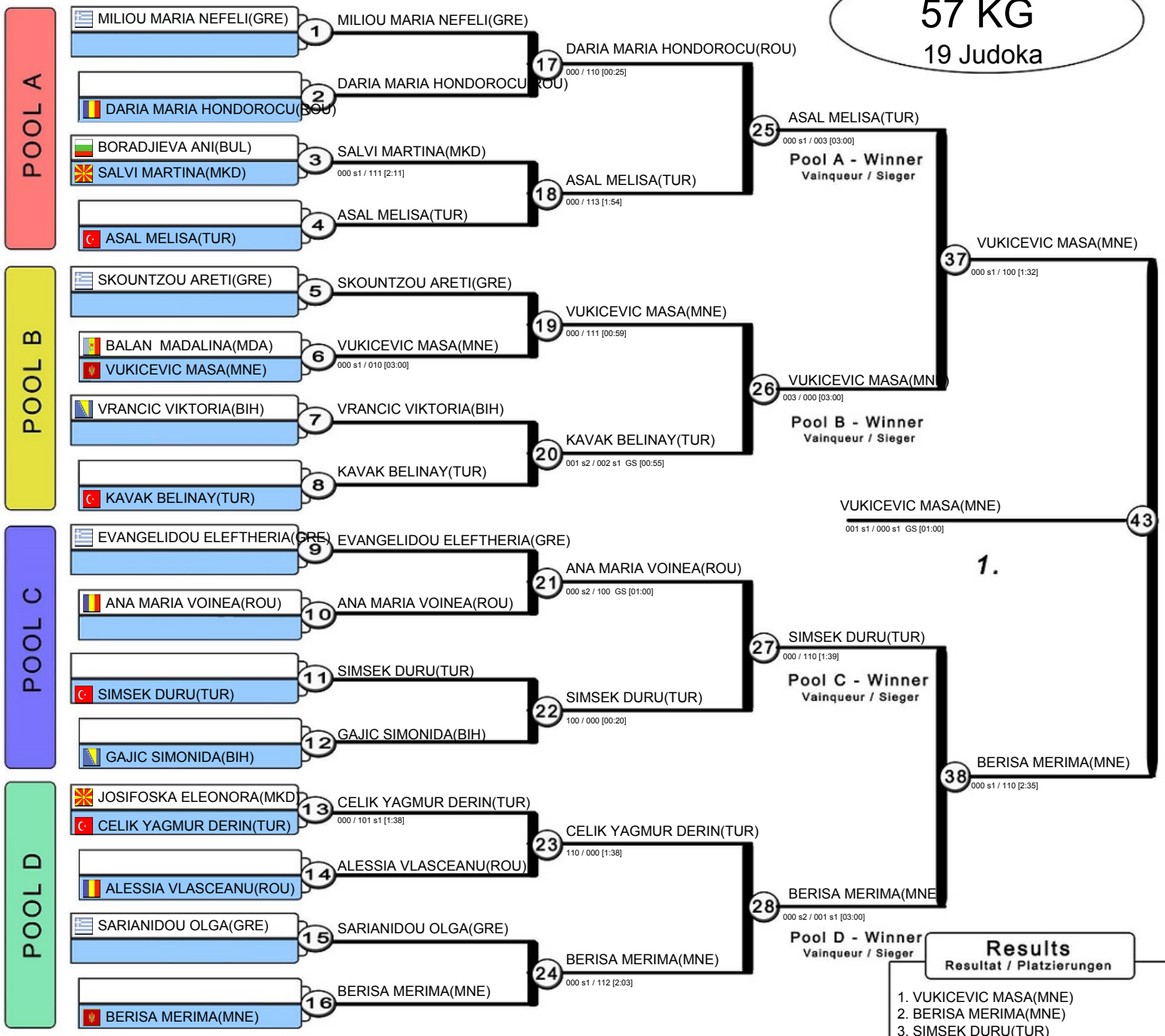

Results

Resultat / Platzierungen

1. VUKICEVIC MASA (MNE)
2. BERISA MERIMA (MNE)
3. SIMSEK DURU (TUR)
3. CELIK YAGMUR DERIN (TUR)
5. DARIA MARIA HONDOROCU (ROU)
5. ASAL MELISA (TUR)
7. KAVAK BELINAY (TUR)
7. ANA MARIA VOINEA (ROU)

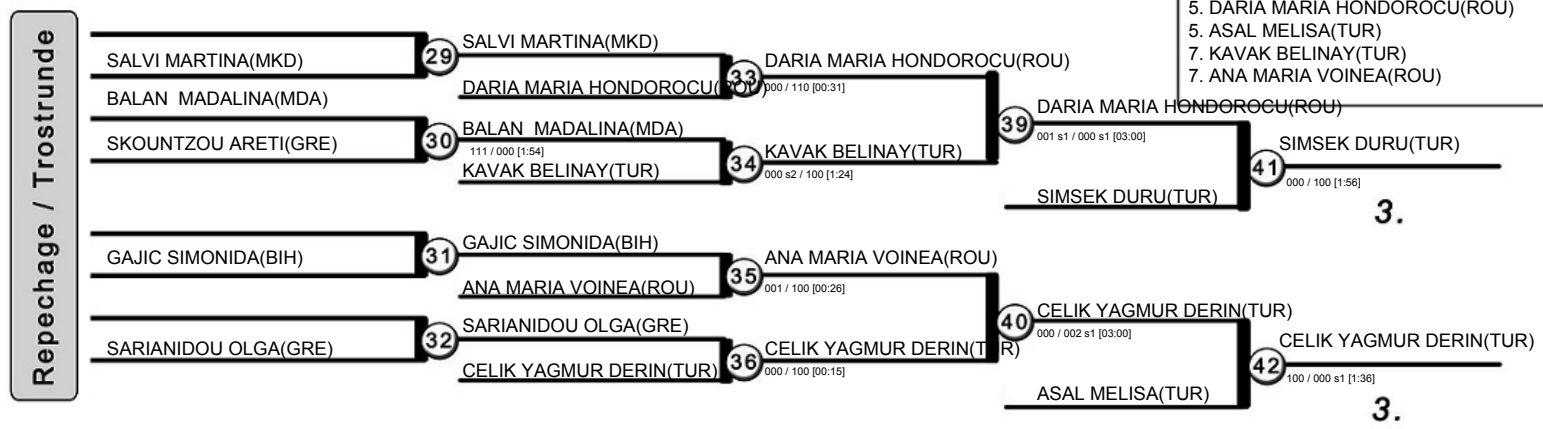



BALKAN JUDO ASSOCIATION

BALKAN JUDO CHAMPIONSHIP BOYS AND GIRLS U14

June 06 07, 2026 - BITOLA, NORTH MACEDONIA

63 KG
17 Judoka

POOL A

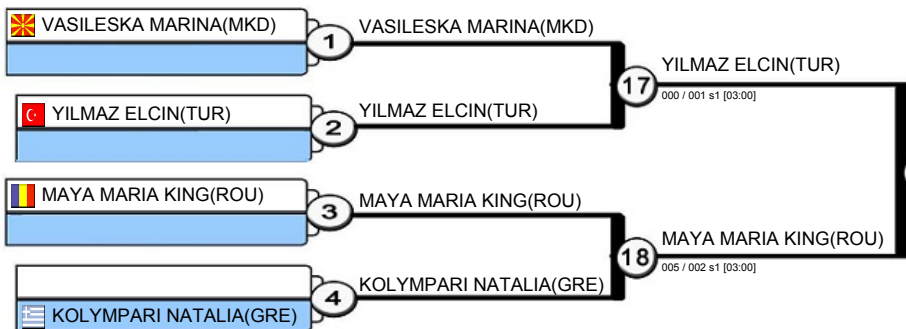

Pool A - Winner
Vainqueur / Sieger

POOL B

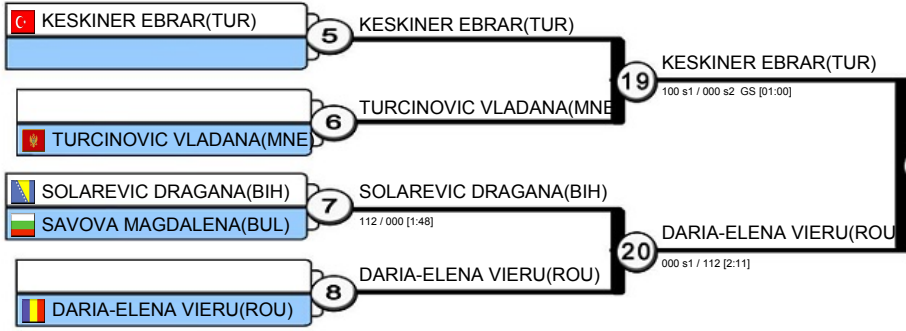

Pool B - Winner
Vainqueur / Sieger

POOL C

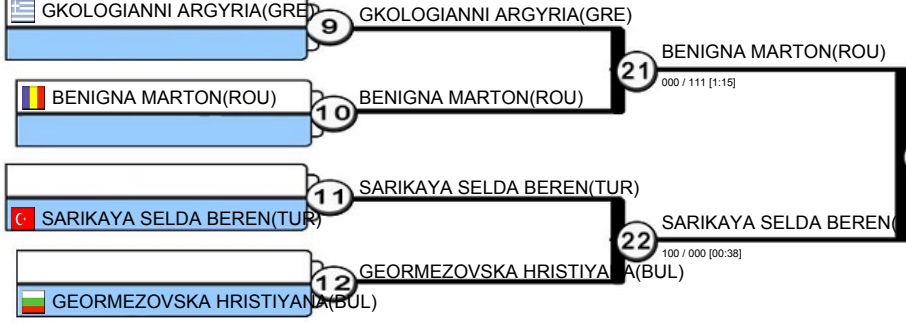

Pool C - Winner
Vainqueur / Sieger

POOL D

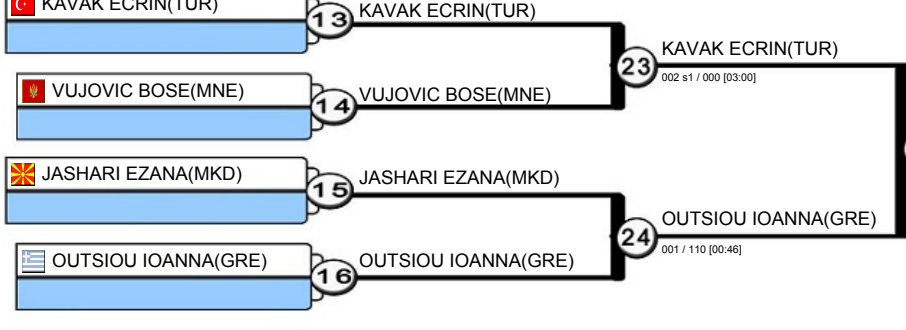

Pool D - Winner
Vainqueur / Sieger

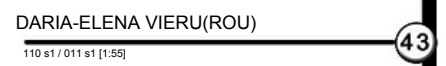

1.

- Results**
Resultat / Platzierungen
- DARIA-ELENA VIERU(ROU)
 - SARIKAYA SELDA BEREN(TUR)
 - YILMAZ ELCIN(TUR)
 - MAYA MARIA KING(ROU)
 - KAVAK ECRIN(TUR)
 - OUTSIU IOANNA(GRE)
 - GEORMEZOVSKA HRISTIJANA(BUL)

Repechage / Trostrunde

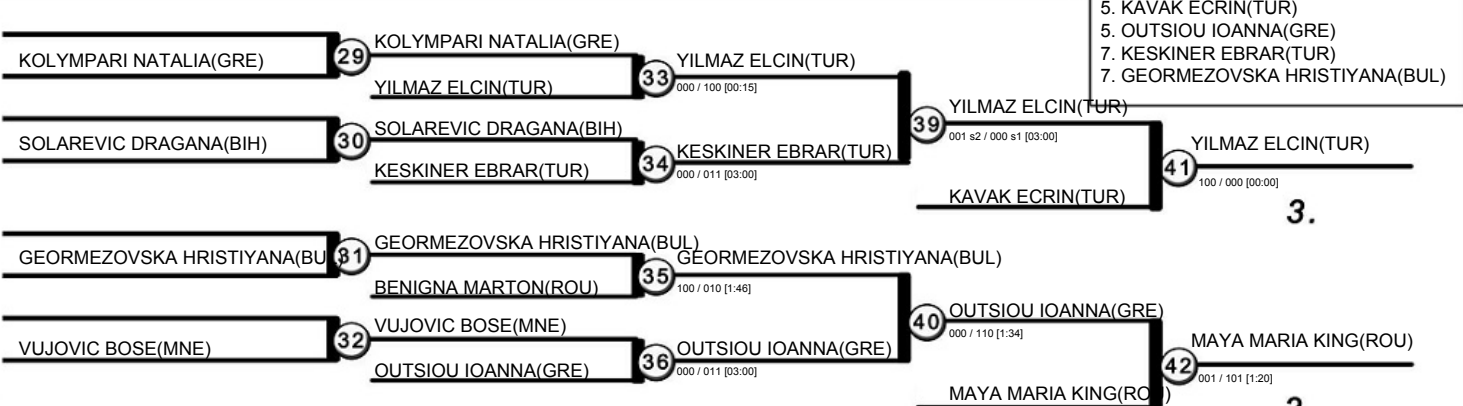

3.

3.



BALKAN JUDO ASSOCIATION

BALKAN JUDO CHAMPIONSHIP BOYS AND GIRLS U14

June 06 - 07, 2026 - BITOLA, NORTH MACEDONIA

+63 KG
21 Judoka

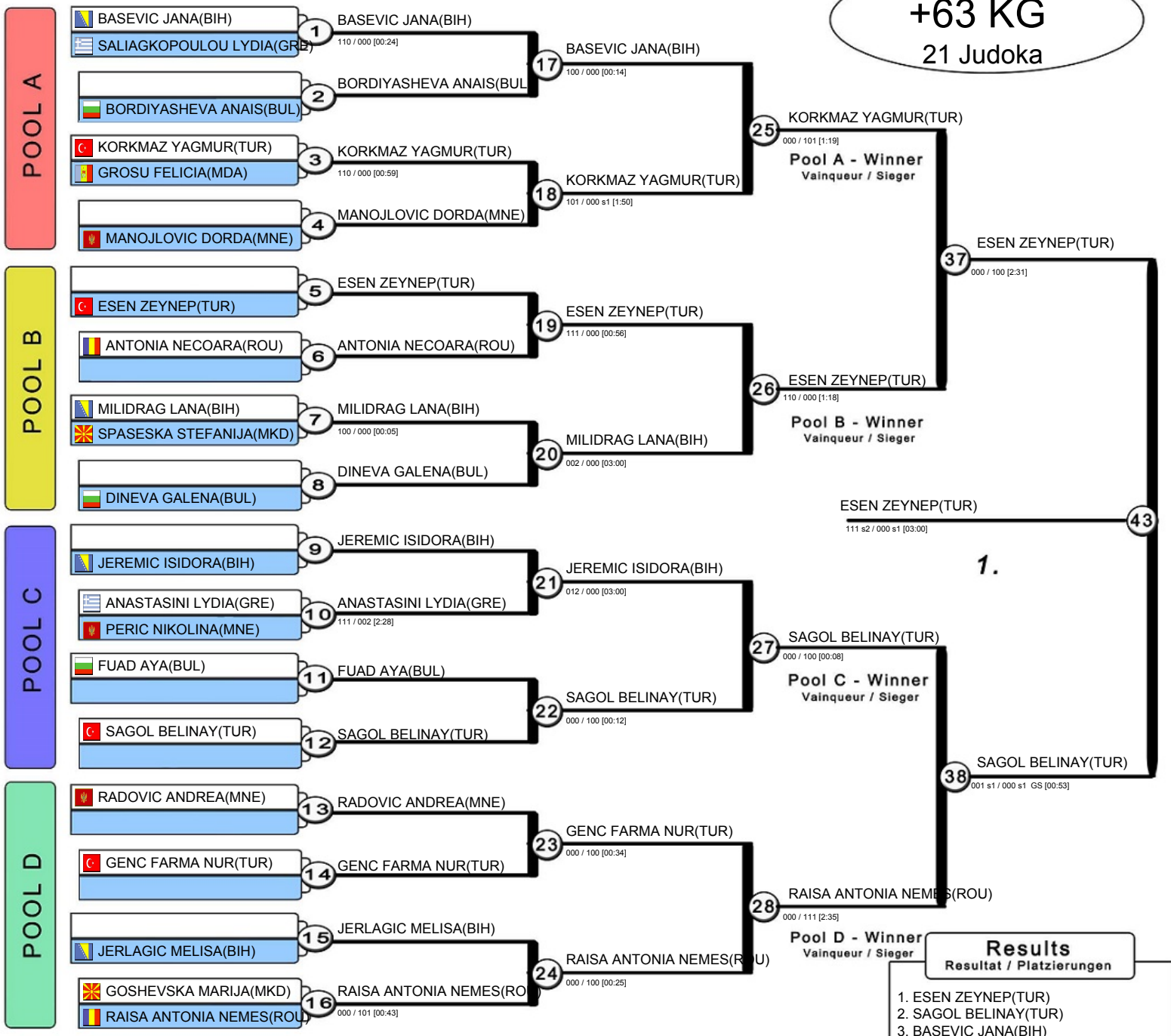

- Results**
Resultat / Platzierungen
- ESEN ZEYNEP (TUR)
 - SAGOL BELINAY (TUR)
 - BASEVIC JANA (BIH)
 - KORKMAZ YAGMUR (TUR)
 - RAISA ANTONIA NEMES (ROU)
 - JEREMIC ISIDORA (BIH)
 - MILIDRAG LANA (BIH)
 - JERLAGIC MELISA (BIH)

